

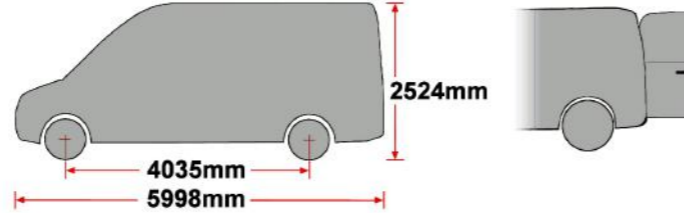

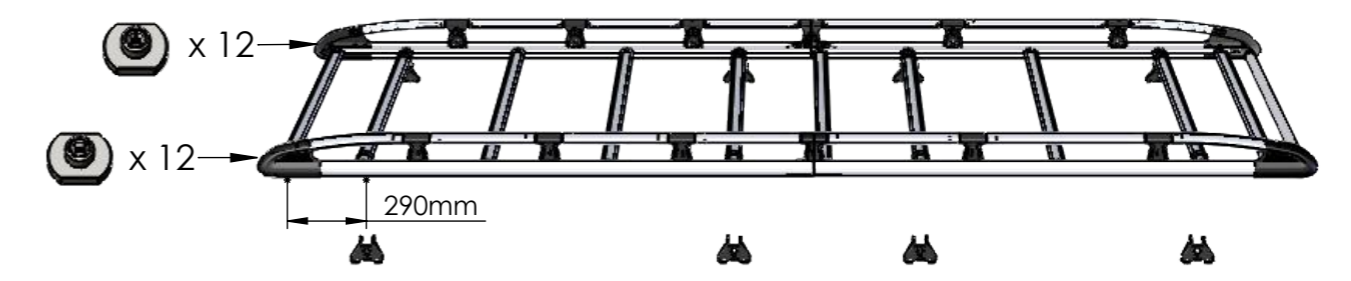



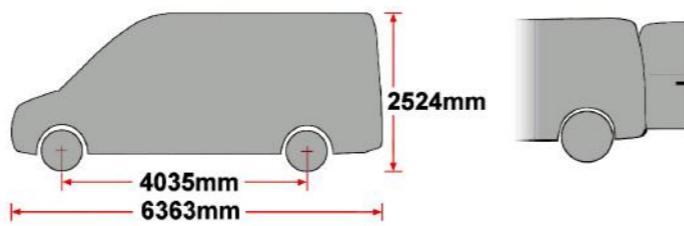
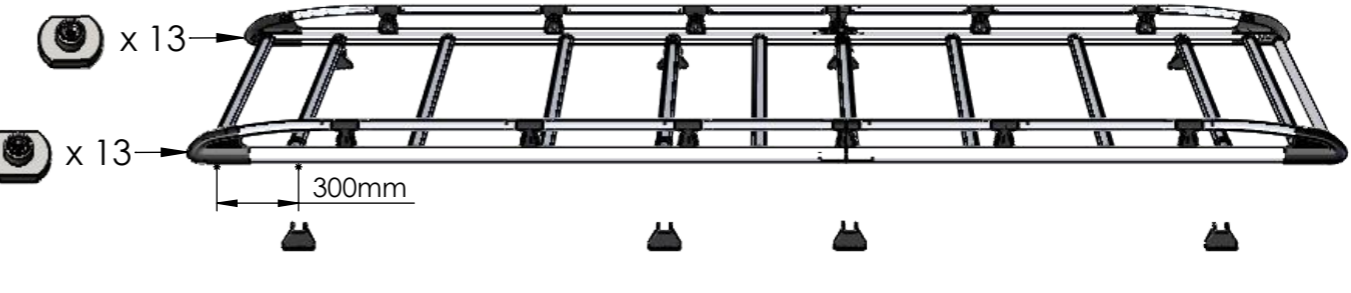

<h1>A548</h1>  <p>51kg + xx kg = Max. 150kg</p>	<p>JUMPER/RELAY/BOXER/DUCATO 2006- L3, H2, TWIN DOORS</p>  <p>4035mm 5998mm 2524mm</p>	<p>AMP20 + AMP18 = 3.8m</p>  <p>x 12 x 12 290mm</p>
--	---	--

<h1>A587</h1>  <p>55kg + xx kg = Max. 150kg</p>	<p>JUMPER/RELAY/BOXER/DUCATO 2006- L4, H2, TWIN DOORS</p>  <p>4035mm 6363mm 2524mm</p>	<p>AMP24 + AMP18 = 4.2m</p>  <p>x 13 x 13 300mm</p>
---	--	---

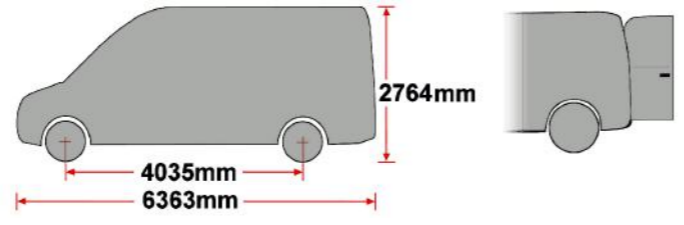
<h1>A618</h1>  <p>48kg + xx kg = Max. 150kg</p>	<p>JUMPER/RELAY/BOXER/DUCATO 2006- L4, H3, TWIN DOORS</p>  <p>4035mm 6363mm 2764mm</p>	<p>AMP24 + AMP18 = 4.2m</p>  <p>x 13 x 13 300mm</p>
--	---	--

<h1>A652</h1>  <p>44kg + xx kg = Max. 150kg</p>	<p>JUMPER/RELAY/BOXER/DUCATO 2006- L3, H3, TWIN DOORS</p>  <p>4035mm 5998mm 2764mm</p>	<p>AMP18 + AMP18 = 3.6m</p>  <p>x 11 x 11 300mm</p>
--	---	--

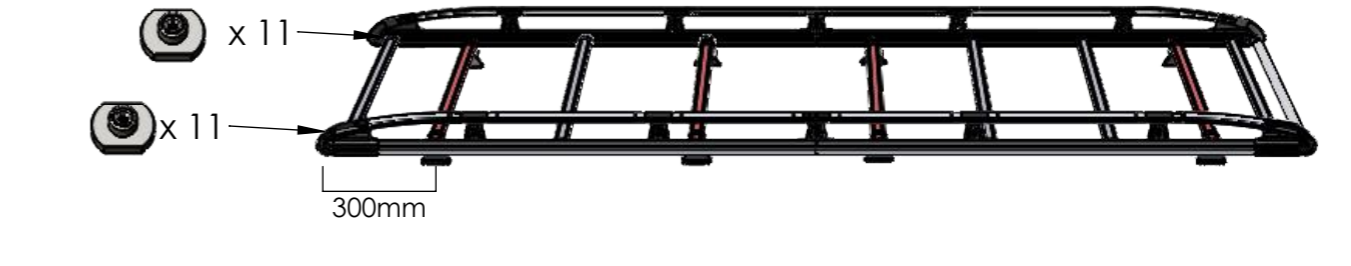
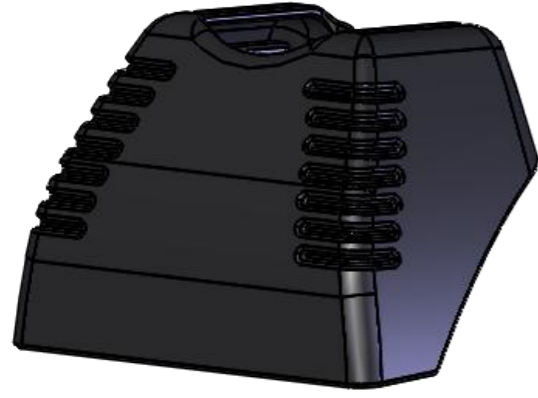

PS095 x 8

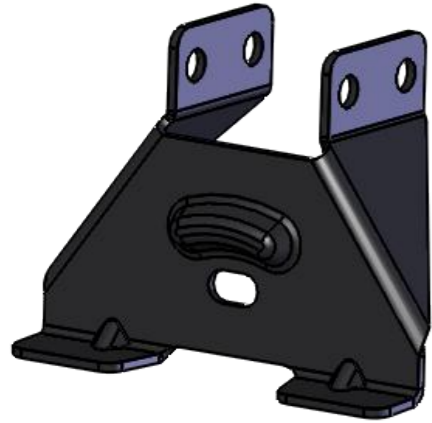

MS170 x 8



EXT09-004 x 8

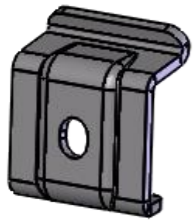

MS202 x 8



PS089 x 1



PS047 x 8



PS090 x 1



FB012 (M8 x 65) x 16

(1:1)

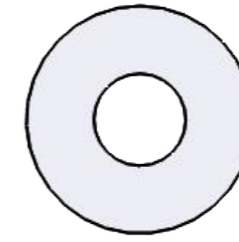

FW002 (M8) x 32



FN006 (M8) x 26



FS066 (M8 x 40) x 8

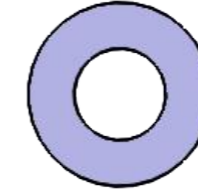

FW021 (M8) x 16



PS065 x 8



FS059 (M8 x 25) x 32

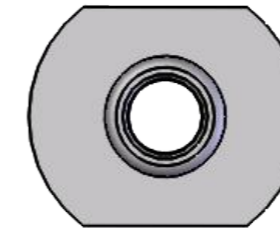

FN023 (M8) x 26

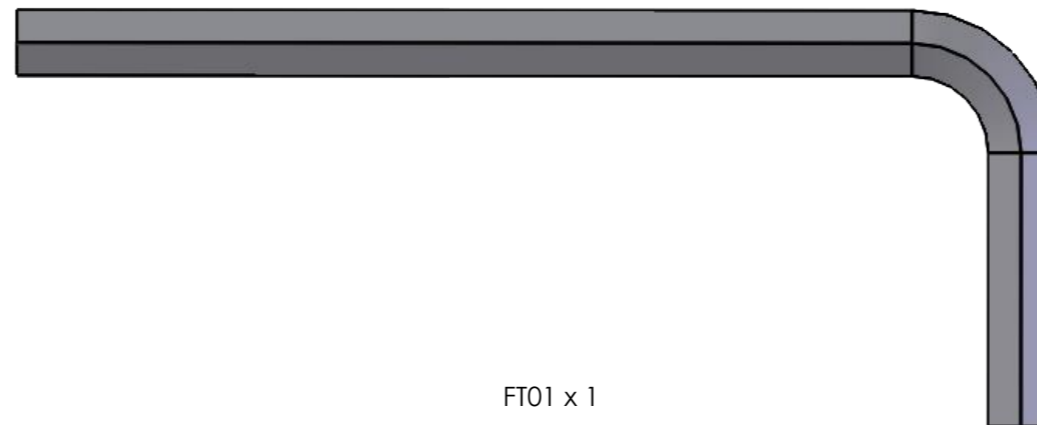

FT01 x 1

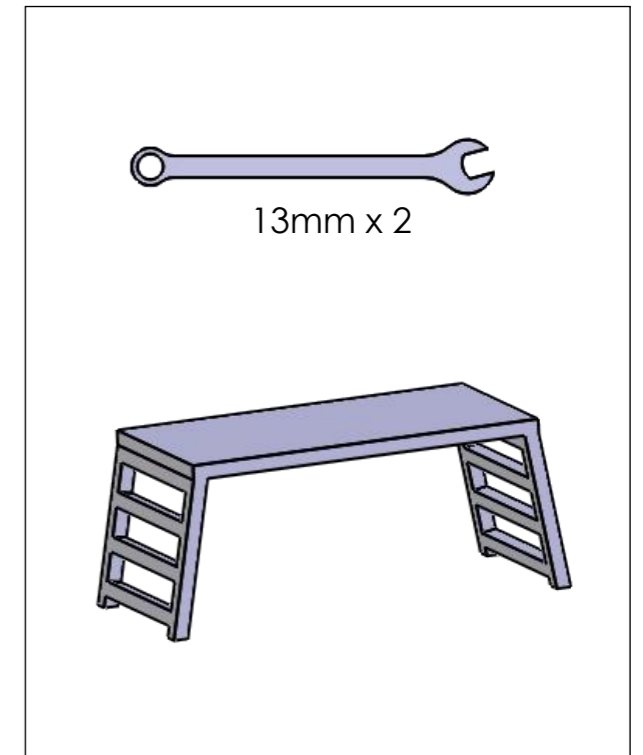

13mm x 2

